

ADVANCE DOCK LIFTS[®]

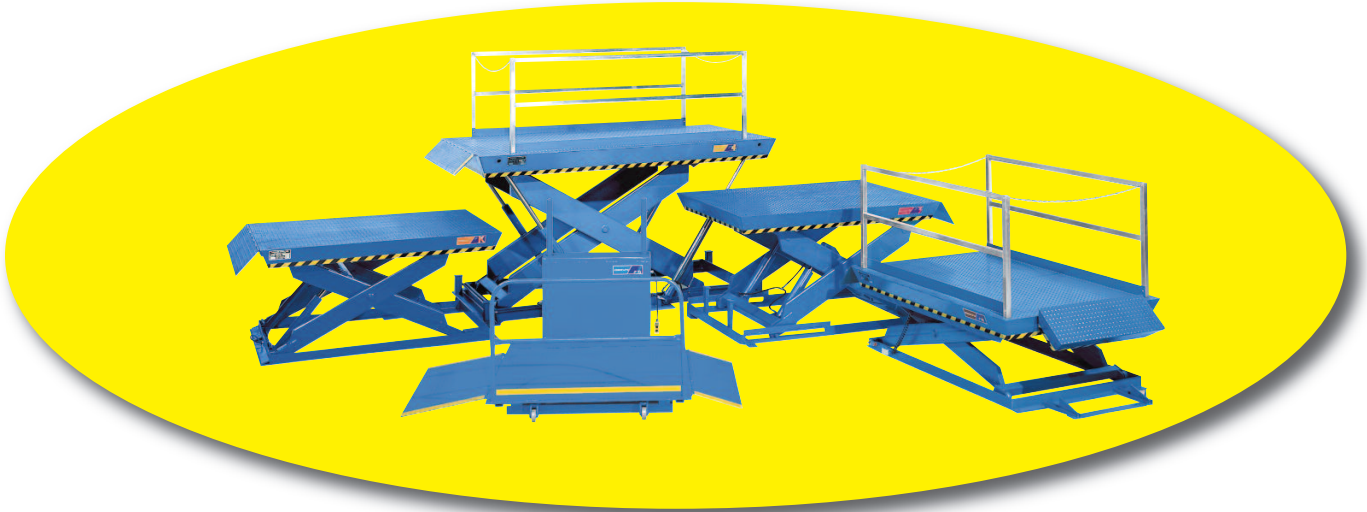

**Truck unloading with
Advance Dock Lifts
offers BIG SAVINGS!**

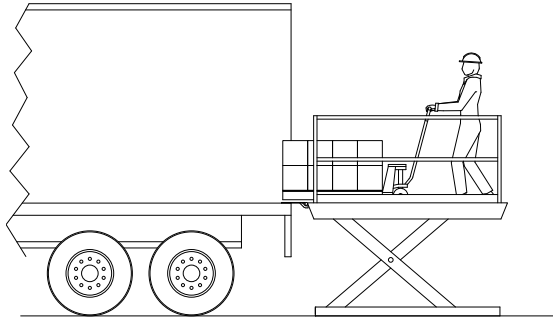



ADVANCE DOCK LIFTS ARE FAST, SAFE, EFFICIENT & VERSATILE

DOCK LIFTS VERSUS NOTHING:

Unloading trucks without any equipment is very slow and puts dock personnel at risk for shoulder, back and metatarsal injuries. Also, goods may be damaged.

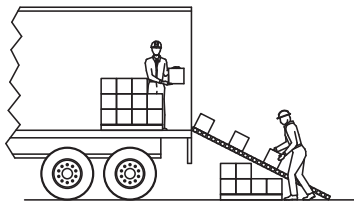
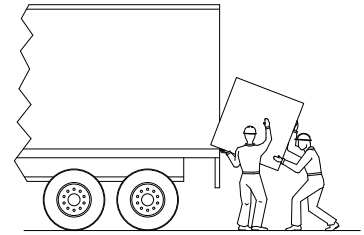

DOCK LIFTS VERSUS CONVEYOR UNLOADING:

Conveyor unloading is 2 to 3 times slower than using a dock lift. It leaves personnel at risk of shoulder, back and metatarsal injuries and goods are at risk.

DOCK LIFTS VERSUS TRUCK TAILGATES:

Tailgates and their maintenance are more expensive than dock lifts. Tailgates reduce truck payload and increase vehicle wear. Tailgate platforms are smaller and do not offer handrail protection available on dock lifts, more risk for operators and cargo.

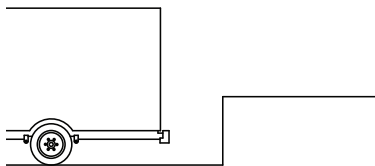
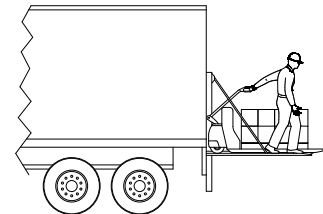

DOCK LIFTS VERSUS DOCK LEVELERS:

Dock levelers can only serve a limited range of truck heights (usually 8") so they cannot serve all size trucks. An Advance dock lift can service any size truck without limitations.

ADVANCE LIFTS OFFERS:

- ▶ **The most recessed dock lift models.**
- ▶ **The most top of ground dock lift models.**
- ▶ **Coast to coast turn key service.**

**That is why Advance Lifts has been the #1 dock lift builder
in the country for over 50 years.**



1-800-THE-DOCK (800-843-3625) advancelifts.com

ADVANCE DOCK LIFTS CAN PROVIDE TRUCK OWNERS AND BUILDING OWNERS BIG SAVINGS!

Truck owners can speed up truck turnaround time!

1. Trucks earn money by moving, not standing still during loading and unloading.
2. Unloading a semi at buildings with no docks or low docks can take 2 men 2 hrs.
3. Unloading the same truck using an Advance dock lift can take 1 man as little as 30 to 45 minutes.
4. Similar percentage savings can be attained with city delivery trucks.
5. This can yield more deliveries per truck every day!

Building tenants' savings are huge!

1. Labor man hours for truck unloading can be reduced from 4 to less than 1, which is more than a 300% labor hour savings.
2. Less unloading time means less loss of heat or air conditioning through open doors.
3. Level loading with Advance dock lifts is much safer than hand unloading, which means there is far less risk of worker injuries and workers' compensation claims.
4. Level loading with Advance dock lifts reduces the chance of damaged goods.
5. Level loading with Advance dock lifts allows easier loading of back-haul items.

WHEN THERE IS NO LOADING DOCK OR THE DOCK IS TOO HIGH OR TOO LOW TO MATCH A TRUCK HEIGHT

YOU NEED A DOCK LIFT!

**#1 SELLING DOCK LIFT IN THE U.S. FOR OVER 50 YEARS.
WE HAVE SIZES AND STYLES TO MATCH ANY APPLICATION.**



1-800-THE-DOCK (800-843-3625) advancelifts.com



ADVANCE LIFTS®

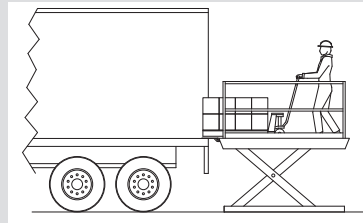
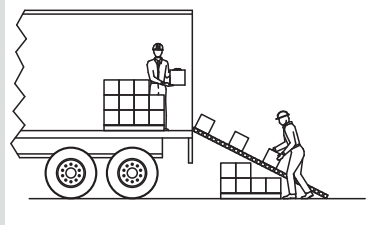

JUST (1) LOWER BACK INJURY

OR

(1) TORN ROTATOR CUFF

OR

(1) SMASHED METATARSAL

CAN COST MORE THAN (1) DOCK LIFT

• PROTECT WORKERS • SAVE MONEY • INCREASE EFFICIENCY

INSTALL AN ADVANCE DOCK LIFT

ADVANCE LIFTS NATIONAL ACCOUNTS PROGRAM

National account programs establish advantageous pricing and have two ways to administer them: single-point centralized purchasing, where all the dock lifts are purchased and coordinated through a single distributor, or dispersed contractor purchasing, where the company specifies an Advance dock lift, and the actual purchasing is done through contractors using a distributor local to the site.

ADVANCE LIFTS ADVANTAGES

- ▶ #1 Dock Lift Builder in North America.
- ▶ Industry's most complete line of dock lifts in both top of ground and recessed units.
- ▶ Sales, service, and installation arranged anywhere in the US. No location is too remote.
- ▶ Industry's best warranty.
- ▶ On time production.
- ▶ Shortest lead times in the industry.
- ▶ Over 50 years of experience successfully serving the nation's largest retailers.



1-800-THE-DOCK (800-843-3625) advancelifts.com



ADVANCE LIFTS®

DISAPPEARING DOCK LIFT

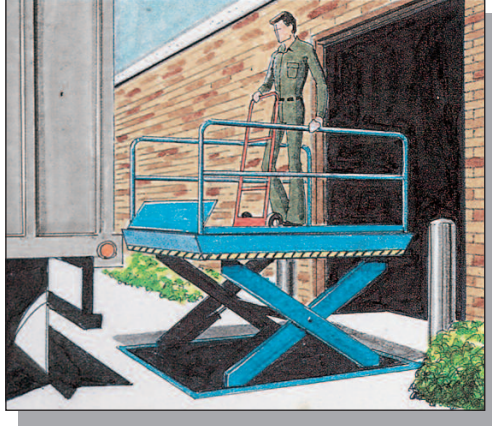

NOW YOU SEE IT

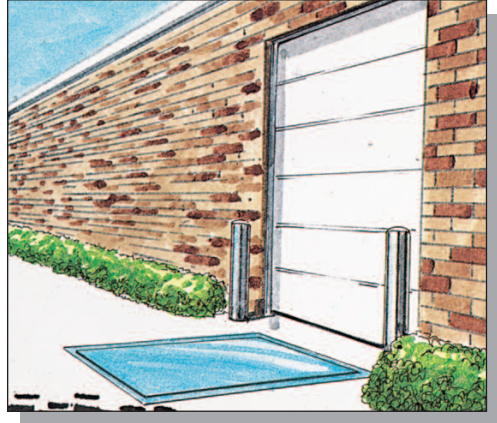

NOW YOU DON'T

***AN ADVANCE DOCK LIFT IS THE ONLY EQUIPMENT
THAT CAN SERVICE ALL TRUCKS.***

- **WHITE PAPER (SELECTION GUIDE)**
- **LIFT SPECIFICATIONS SHEETS**
- **ARCHITECTURAL SPECIFICATIONS**
- **PIT & PAD DRAWINGS**

INSTANT DOCK LIFT

- **PROTECT WORKER**
- **SAVE MONEY**
- **INCREASE EFFICIENCY**



**LAG IT DOWN & PLUG IT IN
YOU HAVE AN INSTANT DOCK**



1-800-THE-DOCK (800-843-3625) advancelifts.com



Our state of the art 120,000 square foot building houses all operations including sales, design and manufacturing. Our company is ISO 9001 certified and we also have a UL listed panel shop in-house.

Advance Lifts was founded in 1974 and quickly became the leading dock lift manufacturer in the country. We have maintained that position through innovative design, quick deliveries and superior service. Our modern 120,000 sq. ft. facility in St. Charles, Illinois houses state of the art equipment and is manned by a well trained group of employees who are dedicated to providing our customers outstanding products. Our goal is to make the entire process of buying, installing, using and servicing of our products, as easy and trouble free as possible for our customers.

Part of our service program includes the most complete website in the industry. Our website, advancedocklifts.com, is available 24/7 and contains interactive product selection aids, photos, operational specifications, architectural specifications, installation drawings, product manuals and a listing of our nationwide distributor network. Therefore, if you have a question, you can get answers by calling a local distributor, calling the factory direct or visiting our website.

Why it pays to buy from an Advance distributor!

Sales – Advance distributor sales engineers are trained to help you apply the correct equipment to your specific application, thereby saving you time and money and precluding costly misapplications. Because they visit hundreds of facilities each year, they are aware of the latest equipment and techniques to solve your problems.

Installation – Advance distributors can install what they sell, which makes your job easier and assures you the job will be done right and the equipment will function to your satisfaction. Their trained technicians have the experience required to meet your installation requirements.

Service – When your equipment needs service, your Advance distributor is right there to help. They have trained service personnel to get you up and running as fast as possible, thereby saving on downtime costs.

Value – It's very simple. Advance distributors save you money by applying the right equipment to the job, making sure it's installed correctly, and making sure you get service when you need it.

Call the Advance distributor nearest you to ensure your project's success.



701 S. Kirk Road
St. Charles, IL 60174
Ph: 1-800-843-3625
Fax: 630-584-9405
www.advancelifts.com

DISTRIBUTED BY: